

PROJECT TITLE :

NOTE :

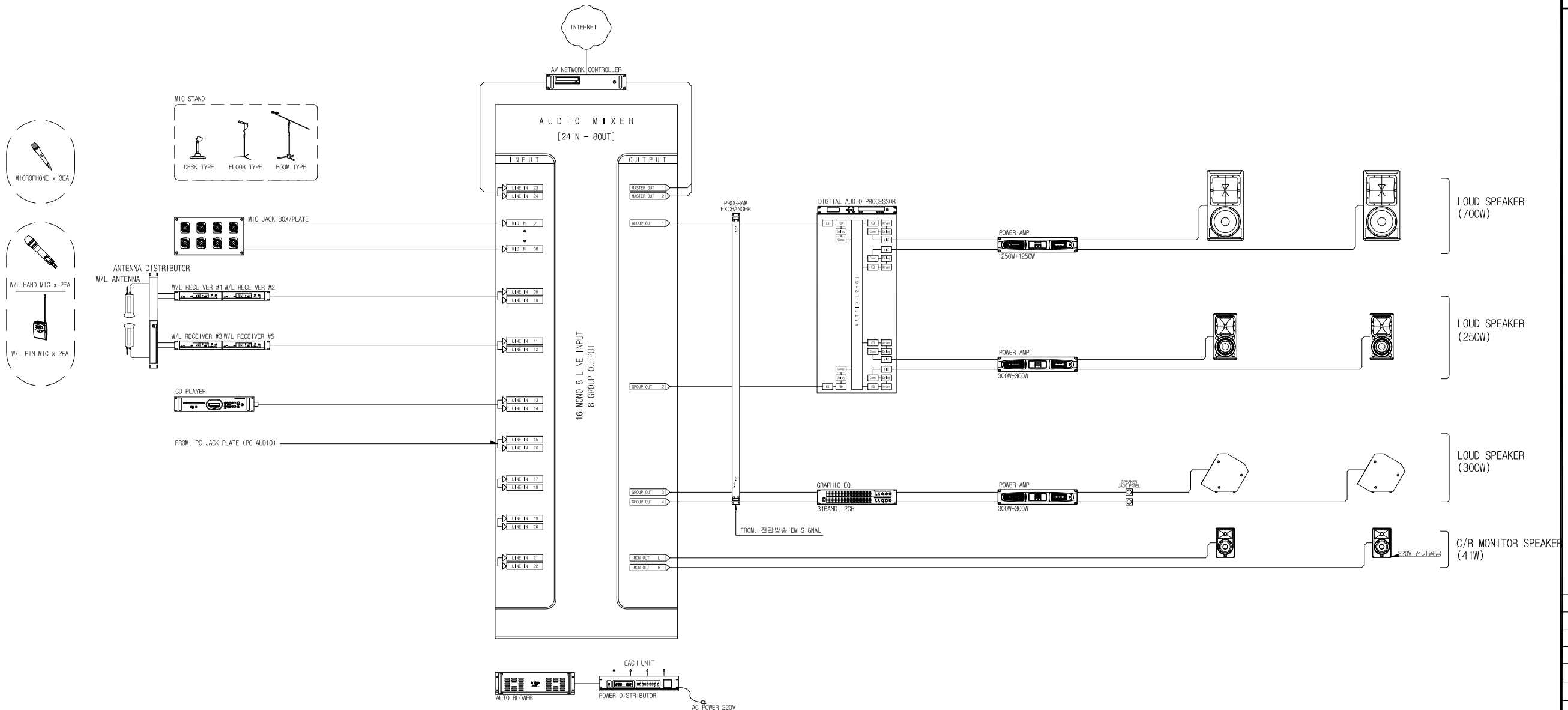

NO.	DESCRIPTION	DATE

DRAWING TITLE :

IBS5250-SW21 계통도-1

DRAWN BY :	SCALE :
REDREWN BY :	1/NONE (A3)
CHECKED BY :	DATA :
APPROVED BY :	

DRAWING NO.

IBS5250-SW21 계통도-1
 SCALE : NONE

PROJECT TITLE :

NOTE :

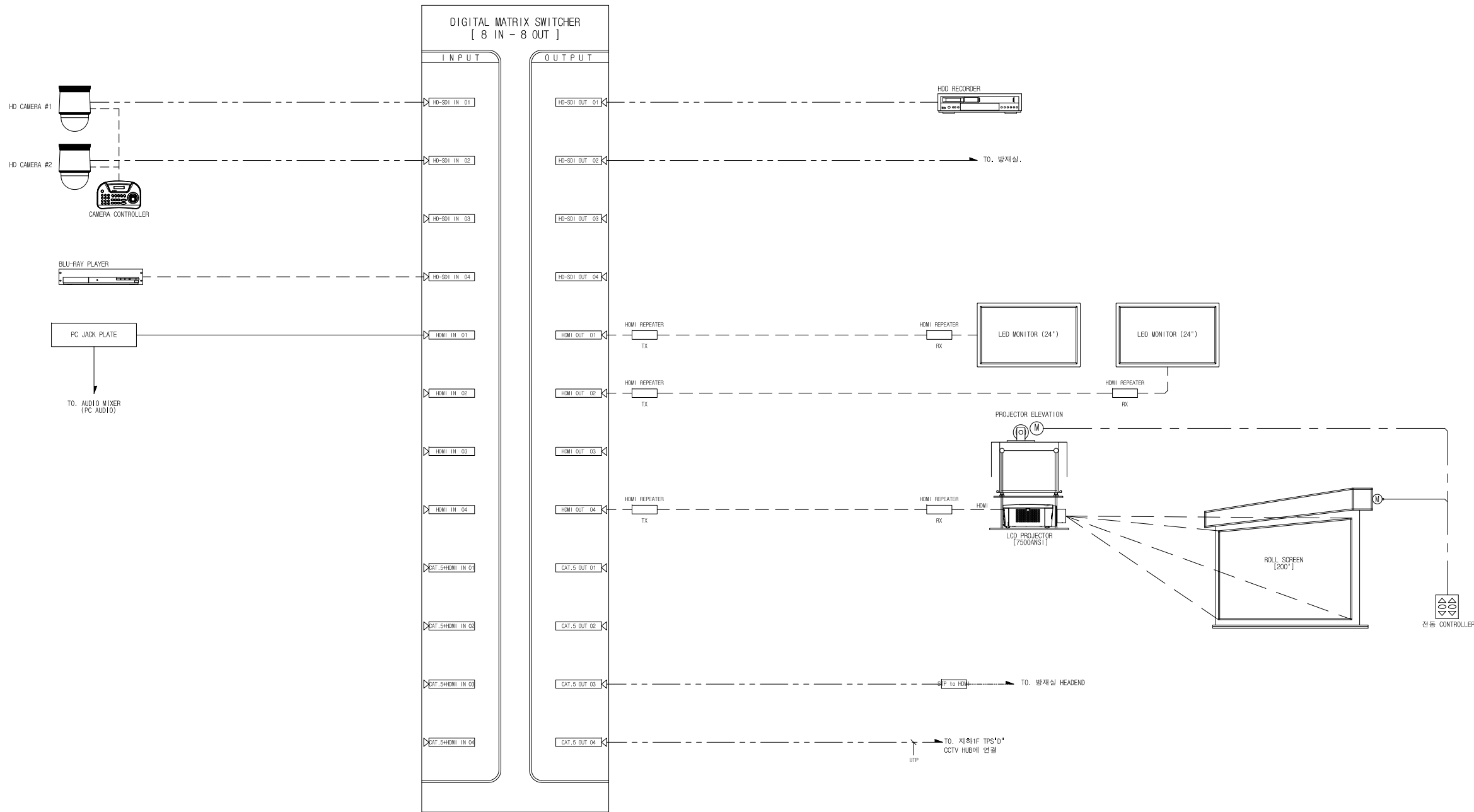

NO.	DESCRIPTION	DATE

DRAWING TITLE :

IBS5250-SW21 계통도-2

DRAWN BY :	SCALE :
REDREWN BY :	1/NONE (A3)
CHECKED BY :	DATA :
APPROVED BY :	

DRAWING NO.

IBS5250-SW21 계통도-2
 SCALE : NONE